



GORILLA GROW CABINET

18" X 24" X 30"

TABLE OF CONTENTS

Overview	3
Unpacking the Grow Cabinet	4
Components	5
Set Up - Elbows & Carbon Filter	6
Set Up - ICF/Thermometer/Hygrometer	7
Set Up - Kind LED Grow Lights	8
Set Up - Grow System	9
Final Assembly	10

LET'S GET GROWING!

Thank you for choosing the Gorilla Grow Cabinet!
We're excited to have you grow with us. Please read through each step of this user manual to get your

Gorilla Grow Cabinet setup for success! With the proper setup and care, this system will give you bountiful harvests for many years to come.

OVERVIEW

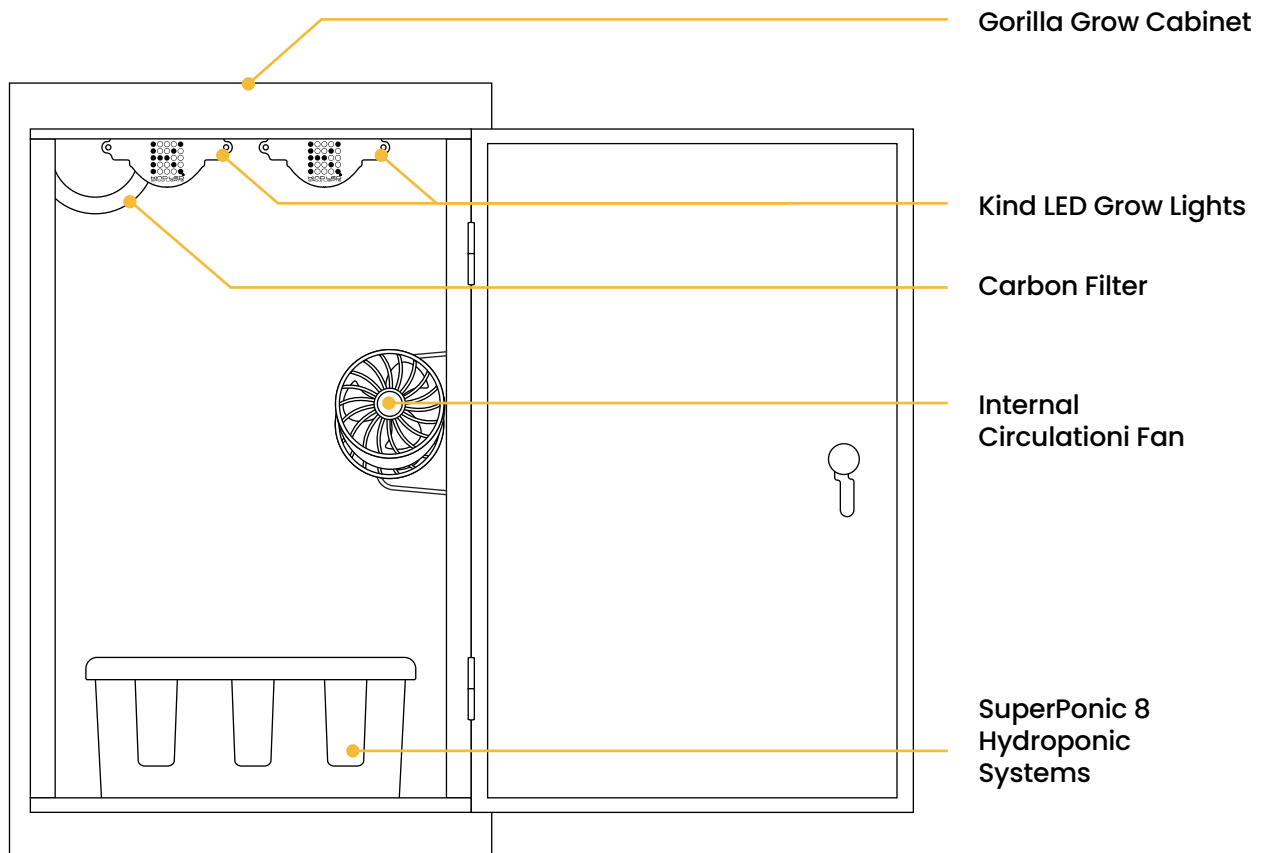

UNPACKING THE GROW CABINET

Carefully unbox the Gorilla Grow Cabinet and remove all contents from inside the cabinet.

Unpack all the contents from the cabinet, as well as any components inside the hydroponic reservoir.

Once all items are unpacked, reference the quality assurance checklist to verify that you have all the

contents of your Gorilla Grow Cabinet.

Make sure you have planned accordingly to ensure you have the proper amount of power and properly sized breakers going to your cabinet. Always consult a professional electrician when setting up and planning your electrical configuration.

Quality Assurance Checklist

	_____
	_____
	_____
	_____
	_____
	_____







NOTE: Prior to setup, make sure you have all of the necessary components by cross referencing with the QAC (Quality Assurance Checklist). Take this time to familiarize yourself with each of the components.

COMPONENTS

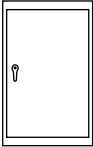

Gorilla Grow Cabinet 1

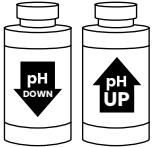

pH Control Kit 1



X40 Kind LED Bar Lights 2

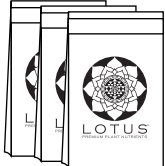

Lotus Nutrients Sample Pack 1

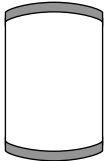

Carbon Filter 1

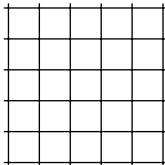

Net Trellis 1

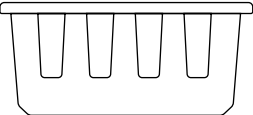

SuperPonic 8 Hydroponic System 2



Smart Plug 2

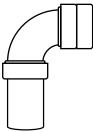

2 in Elbow w/ Extension 2



GFCI Shock Buster 1

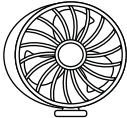

Internal Circulation Fan 1



Industrial Power Strip 1

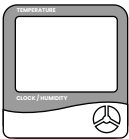

Thermometer / Hygrometer 1

SET UP ELBOWS & CARBON FILTER

Make sure the cabinet is in its final location since it may be challenging to relocate once fully assembled. Do not plug in any of the components

yet, this will be done once the system is completely assembled.



GROW STRONG TIP: Use masking tape and a marker to label the power cords of the components at the plug to help identify the components later in the assembly.

1

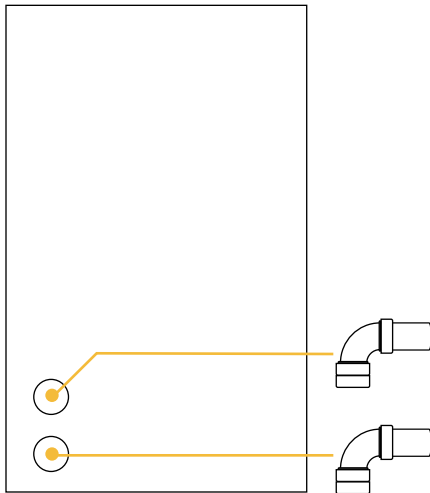

From the outside of the cabinet, insert the foam side of the two 2 in. elbows into holes located at the bottom corner in rear of the cabinet. Be sure to adjust the elbows so the openings face towards the center of the cabinet

The elbows will provide access to run your cords out of the cabinet minimizing light leaks and allow for fresh air flow into the cabinet.

2

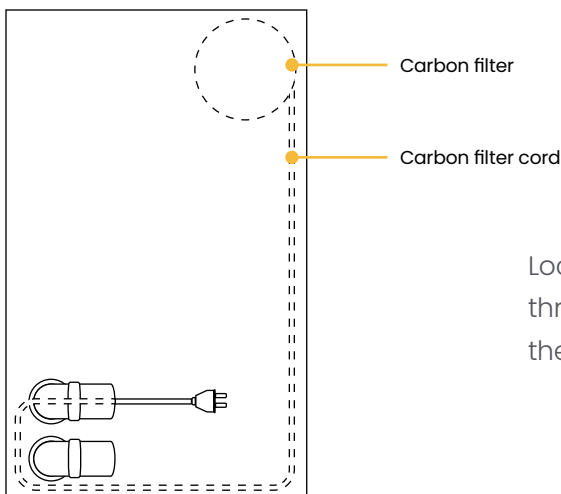

Locate the power cord for the carbon filter and thread the cord through the upper hole found on the lower interior of the cabinet.

SET UP ICF/THERMOMETER/HYGROMETER

1

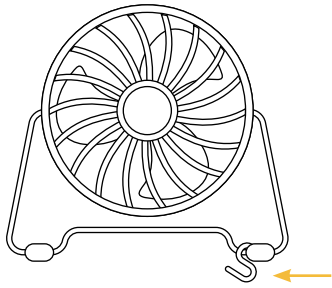

Locate the internal circulation fan. Note the “S” hook connected to the base of the fan. This hook will fit into one of the two provided notches located on the backside of the inner door frame.

2

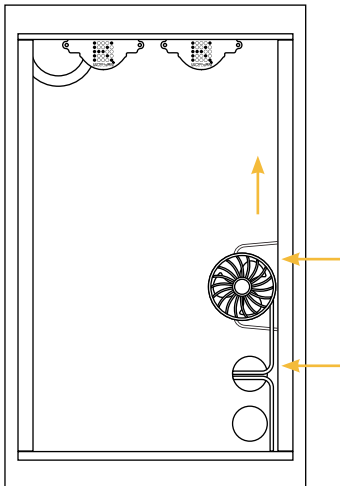

Mount the fan on the lower notch. As your plants grow taller, move the fan to the upper notch. Ideally the fan will blow air across the top of the plants. Thread the power cord through the upper hole found on the lower interior of the cabinet (same as the carbon filter cord).

3

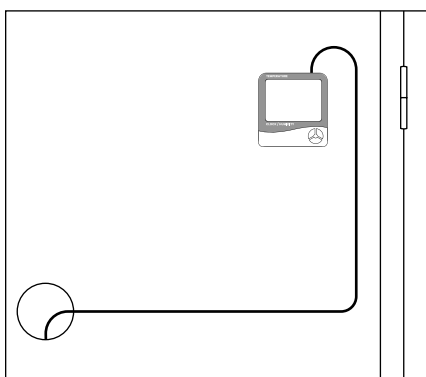

Locate the thermometer/hygrometer. Remove the battery cover and remove the plastic safety blocker from the battery terminal. Use the included velcro strips to affix your thermometer/hygrometer to the inside of your cabinet. The best placement for this is towards the top of the cabinet, either on the side or back wall.

Run the external probe to the outside of the cabinet, through the nearest elbow. Make sure the probe is not touching any surface on the out side of the cabinet as this will provide false readings.

SET UP KIND LED GROW LIGHT



NOTE: The two (2) pre installed Kind LED X40 lights have a protective plastic film on the lenses. This **MUST** be removed prior to operation.

Locate the two (2) LED drivers, daisy chain, and the power cord. Connect one driver to each of the X40 LED cord ends fed through the rear of the cabinet.

Mount the drivers to the rear of the cabinet, via the pre installed screw. Slide the driver horizontally, at slight angle, and line up the center

hole in the driver with the screw. Find the long end of the daisy chain and attach it to light # 1. Connect the short end of the daisy chain to light # 2.

Connect the power cord into the remaining short end of the daisy chain, but do not plug anything into the power strip yet.

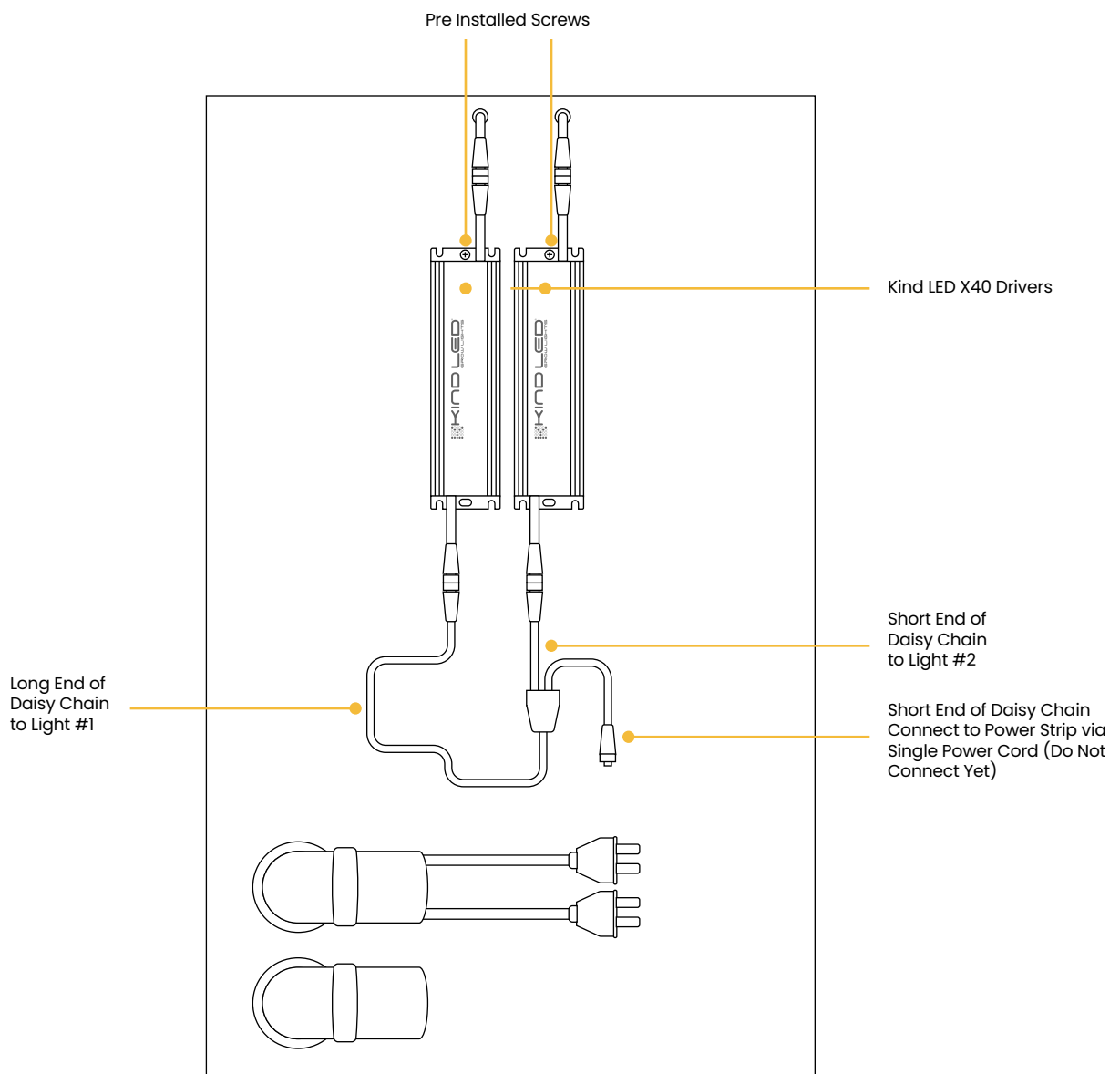

SET UP GROW SYSTEM

To set up your hydroponic system, please refer to the SuperPonic 8 instruction manual.

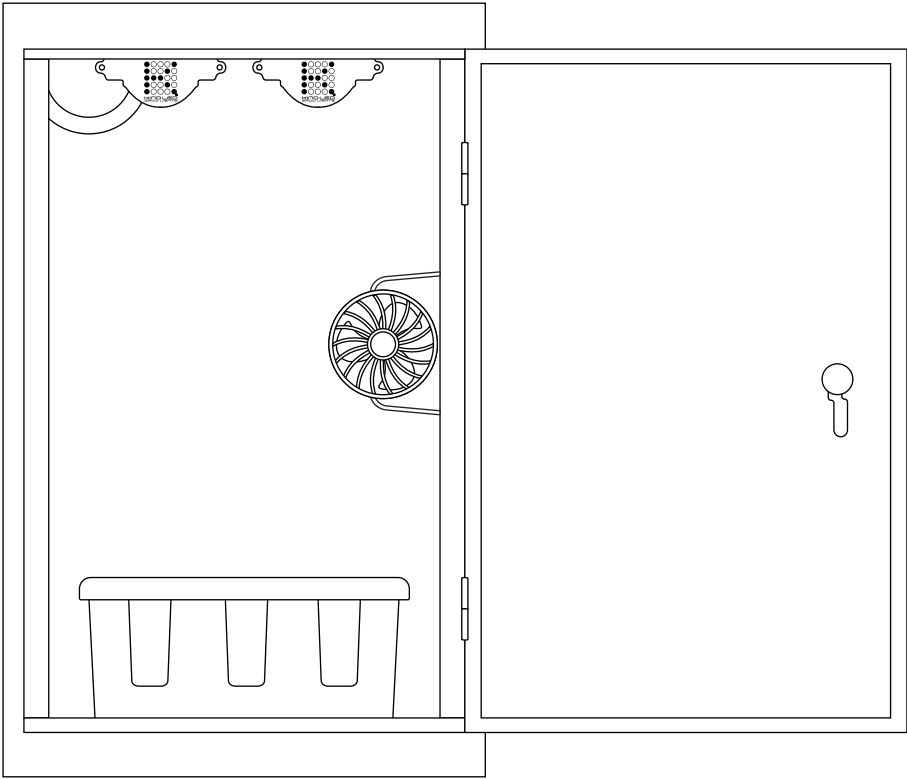

FINAL ASSEMBLY

1

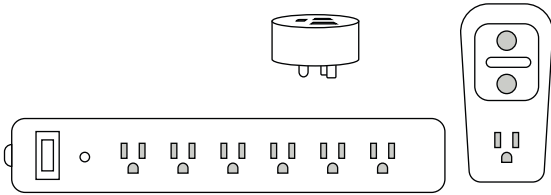

Locate the power strip, the GFCI protector, the smart plug, and the 3-IN-1 adapter.



NOTE: Do not plug in the power strip yet.

Plug the GFCI Protector into any 110v wall socket. With the power strip turned OFF, plug the power strip into the GFCI Protector. Double check to make sure all components are set up properly. it's

time to turn on the Gorilla Grow Cabinet. Turn the power strip switch to the ON position, and the system should spring to life before your very eyes!

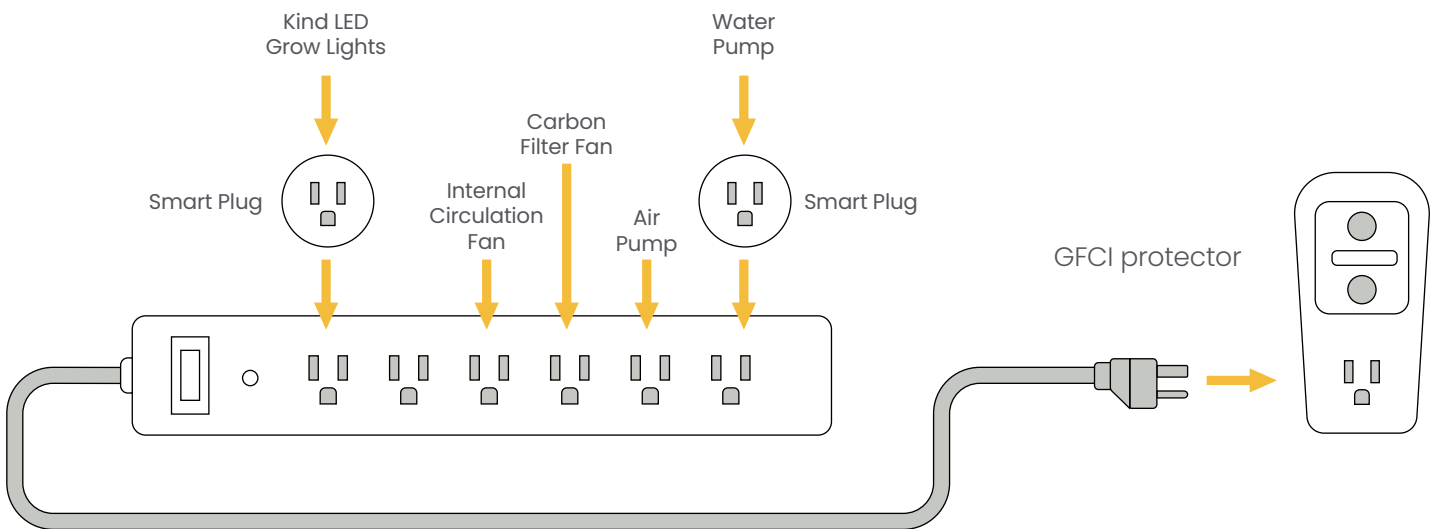

GROW STRONG.®



**NEED ASSISTANCE?
CHECK OUT OUR SUPPORT PORTAL**

WEB: gorillagrowtent.com
SUPPORT: support.growstrongindustries.com
PHONE: 1-855-448-4769