



GORILLA GROW CABINET

24" X 24" X 60"

TABLE OF CONTENTS

Overview	3
Unpacking the Grow Cabinet	4
Components	5
Set Up - Elbows & Power Strip	6
Set Up - Custom Carbon Filter	7
Set Up - Kind LED Grow Light	8
Set Up - Thermometer/Hygrometer/ICF	9
Set Up - Grow System	10
Final Assembly	11

LET'S GET GROWING!

Thank you for choosing the Gorilla Grow Cabinet!
We're excited to have you grow with us. Please read through each step of this user manual to get your

Gorilla Grow Cabinet setup for success! With the proper setup and care, this system will give you bountiful harvests for many years to come.

OVERVIEW

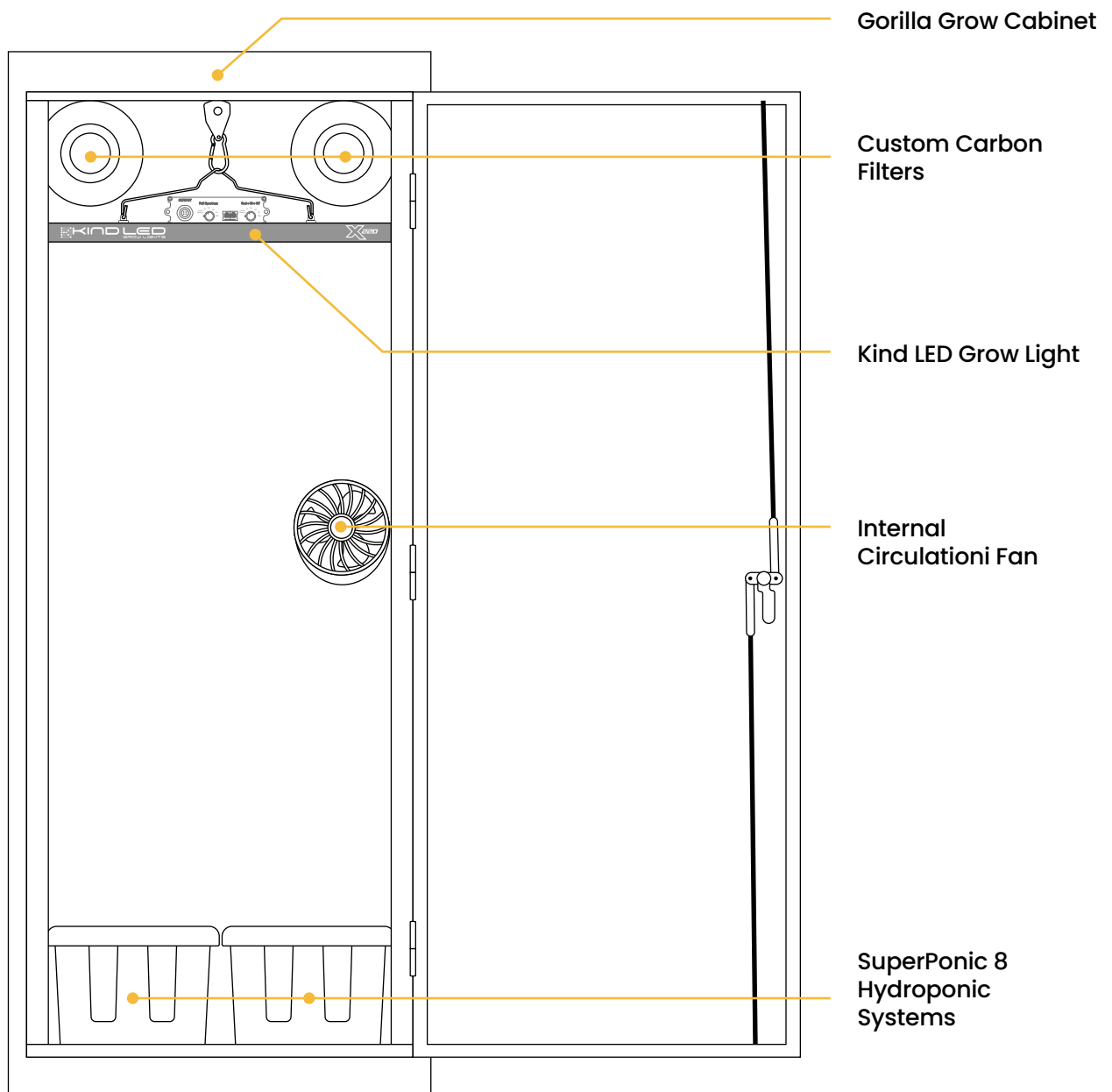

UNPACKING THE GROW CABINET

Carefully unbox the Gorilla Grow Cabinet and remove all contents from inside the cabinet.

Unpack all the contents from the cabinet, as well as any components inside the hydroponic reservoir.

Once all items are unpacked, reference the quality assurance checklist to verify that you have all the

contents of your Gorilla Grow Cabinet.

Make sure you have planned accordingly to ensure you have the proper amount of power and properly sized breakers going to your cabinet. Always consult a professional electrician when setting up and planning your electrical configuration.

Quality Assurance Checklist

☑	_____
☑	_____
☑	_____
☑	_____
☑	_____
☑	_____





[Signature]

[Signature]

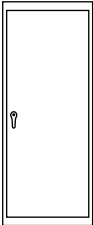
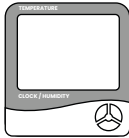
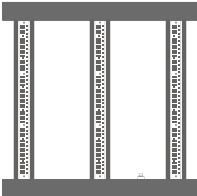
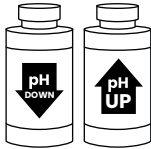
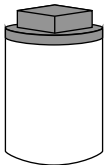
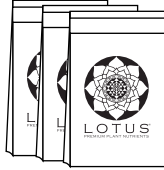
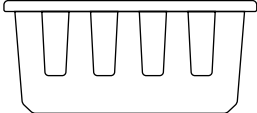
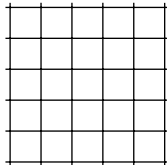

NOTE: Prior to setup, make sure you have all of the necessary components by cross referencing with the QAC (Quality Assurance Checklist). Take this time to familiarize yourself with each of the components.

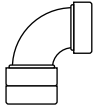
COMPONENTS

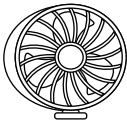
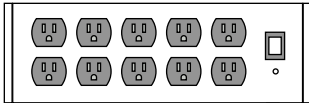
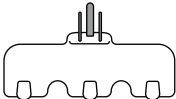
	Gorilla Grow Cabinet	1		Thermometer / Hygrometer	1
	Kind LED Grow Light	1		pH Control Kit	1
	Custom Carbon Filter	2		Lotus Nutrients Sample Pack	1
	SuperPonic 8 Hydroponic System	2		Net Trellis	1
	2 in Elbow	1		Smart Plug	2
	3 in Elbow	2		GFCI Shock Buster	1
	Internal Circulation Fan	1		Industrial Power Strip	1
	3-in-1 Adapter	1			

SET UP ELBOWS & POWER STRIP

Make sure the cabinet is in its final location since it may be challenging to relocate once fully assembled. Do not plug in any of the components

yet, this will be done once the system is completely assembled.



GROW STRONG TIP: Use masking tape and a marker to label the power cords of the components at the plug to help identify the components later in the assembly.

1

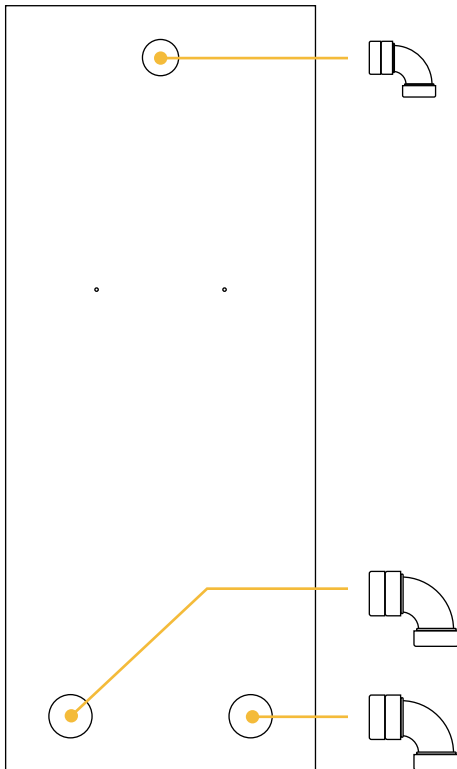

From the outside of the cabinet, insert the foam side of the two 3 in. elbows into large holes located at the bottom corners in rear of the cabinet.

Insert the 2 in. elbow into the middle hole located at the top of the cabinet.

The elbows will provide access to run your cords out of the cabinet minimizing light leaks and allow for fresh air flow into the cabinet.

2

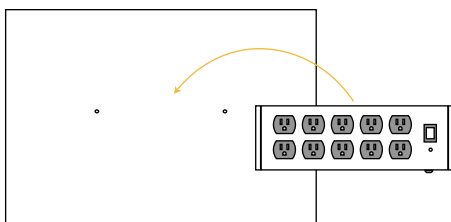

Locate the two screws on the center rear of the cabinet. The power strip has holes on the back that fit these screws for mounting.

SET UP CUSTOM CARBON FILTERS

1

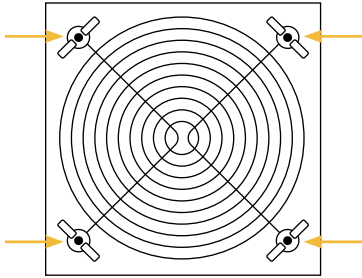

Unpack the custom carbon filters and remove the four wing nuts on the back side of the fan, then remove the fan grill from the fan.

2

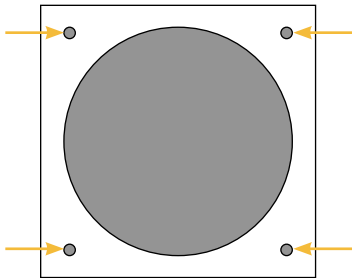

Locate the large opening in the back of the cabinet with the four small surrounding holes. With the help of a partner hold the carbon filter and fan flush to the inside back of the cabinet. Make sure to place the four bolts through the four provided holes. The power cord remains inside the cabinet **NOT THROUGH THE FAN HOLE OPENING.**

3

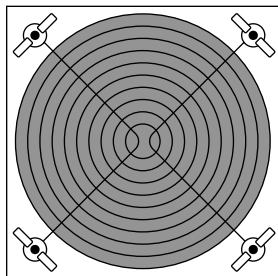

Have a partner place the fan grill on the outside of the cabinet on the four filter fan bolts, then tighten the wing nuts onto the exposed bolts. Repeat the previous steps for the other carbon filter/fan.

Run the power cords for the carbon filter fans through the nearest elbow to the back of the cabinet.

SET UP KIND LED GROW LIGHT

1

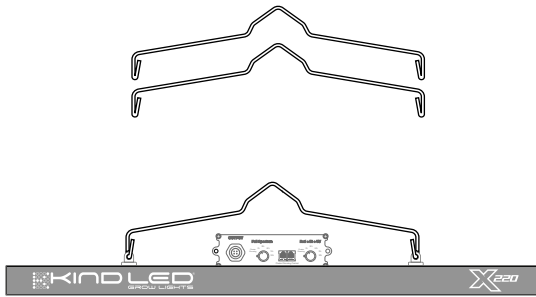

Unpack the KIND LED Grow Light and locate the wire hangers. Connect the wire hangers to each of the metal hangers on the light.

We have set the light on a convenient Yo-Yo system so the height can be adjusted as your plants grow. To lower the light, simply press the button located on the side of the Yo-Yo and adjust to the desired height. To raise the light pull upward on the end of the Yo-Yo cord.

2

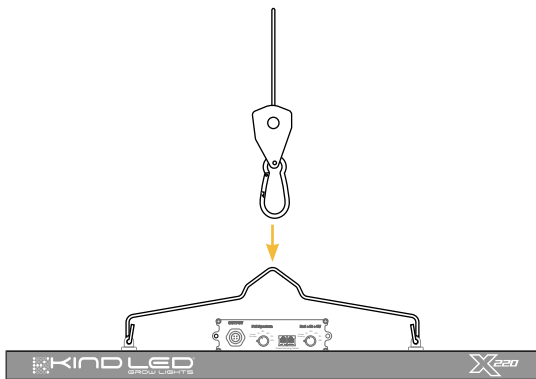

Place the Kind LED Light in the bottom of the cabinet. Lower the Yo-Yo system until you can connect the Yo-Yo carabiners to the center of the wire hangers. Raise the light to the desired height using the loose end of the Yo-Yo hanger cord.

Run the power cord from the LED light through the nearest elbow opening.

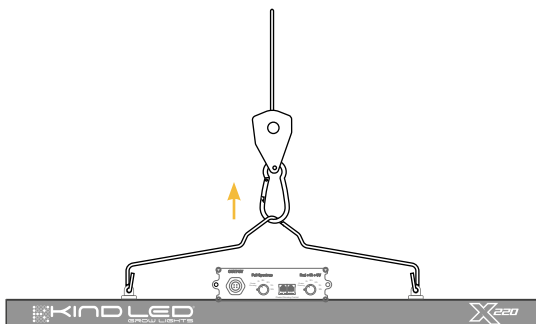

SET UP THERMOMETER/HYGROMETER/ICF

6

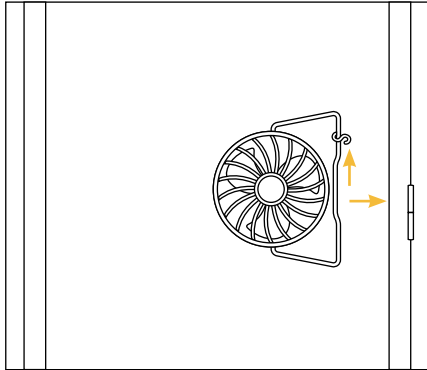

Locate the internal circulation fan. Note the “S” hook connected to the base of the fan. This hook will fit into the notches located on the backside of the inner door frame. Mount the Fan on one of the lower notches. As the plants grow taller, move the fan to the upper notches. Ideally the fan will blow air across the top of the plants. Thread cord through the upper hole found on the lower interior of the cabinet (same as the light power cord).

7

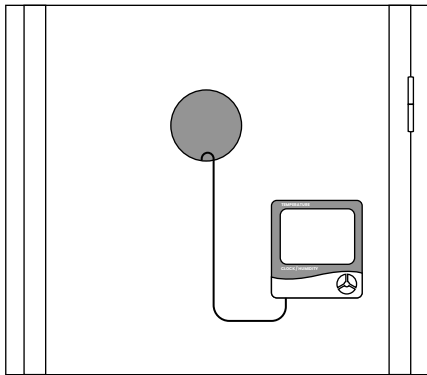

Locate the thermometer/hygrometer. Remove the battery cover and remove the plastic safety blocker from the battery terminal. Use the included velcro strips to affix your thermometer/hygrometer to the inside of your cabinet. The best placement for this is towards the top of the cabinet, either on the side or back wall.

Run the external probe to the outside of the cabinet, through the nearest elbow. Make sure the probe is not touching any surface on the outside of the cabinet as this will provide false readings.

SET UP GROW SYSTEM

To set up your hydroponic system, please refer to the SuperPonic 8 instruction manual.

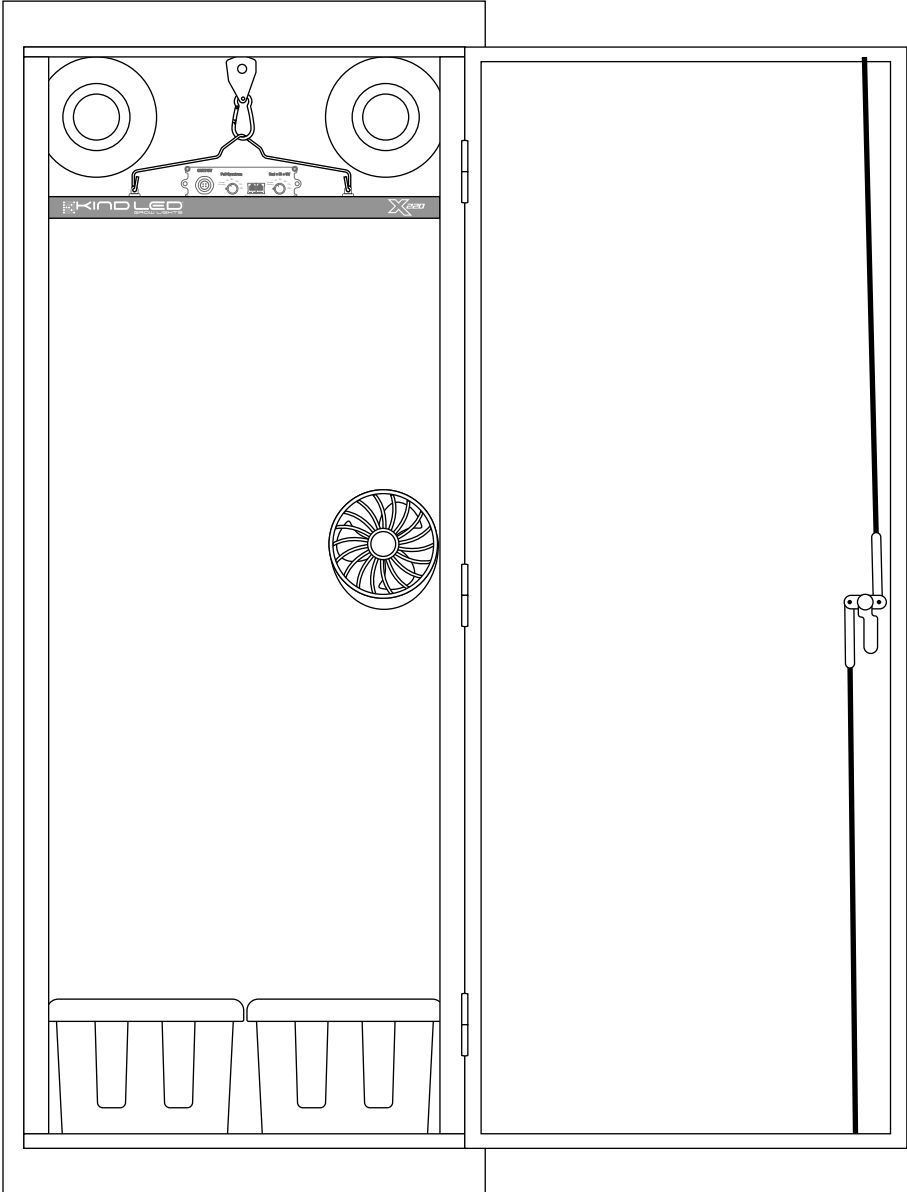

FINAL ASSEMBLY

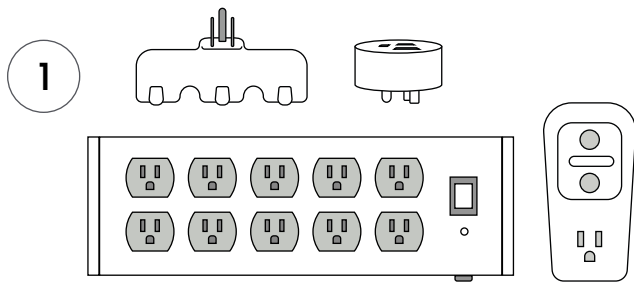

Locate the power strip, the GFCI protector, the smart plug, and the 3-IN-1 adapter.



NOTE: Do not plug in the power strip yet.

Plug the GFCI Protector into any 110v wall socket. With the power strip turned OFF, plug the power strip into the GFCI Protector. Double check to make sure all components are set up properly. it's

time to turn on the Gorilla Grow Cabinet. Turn the power strip switch to the ON position, and the system should spring to life before your very eyes!

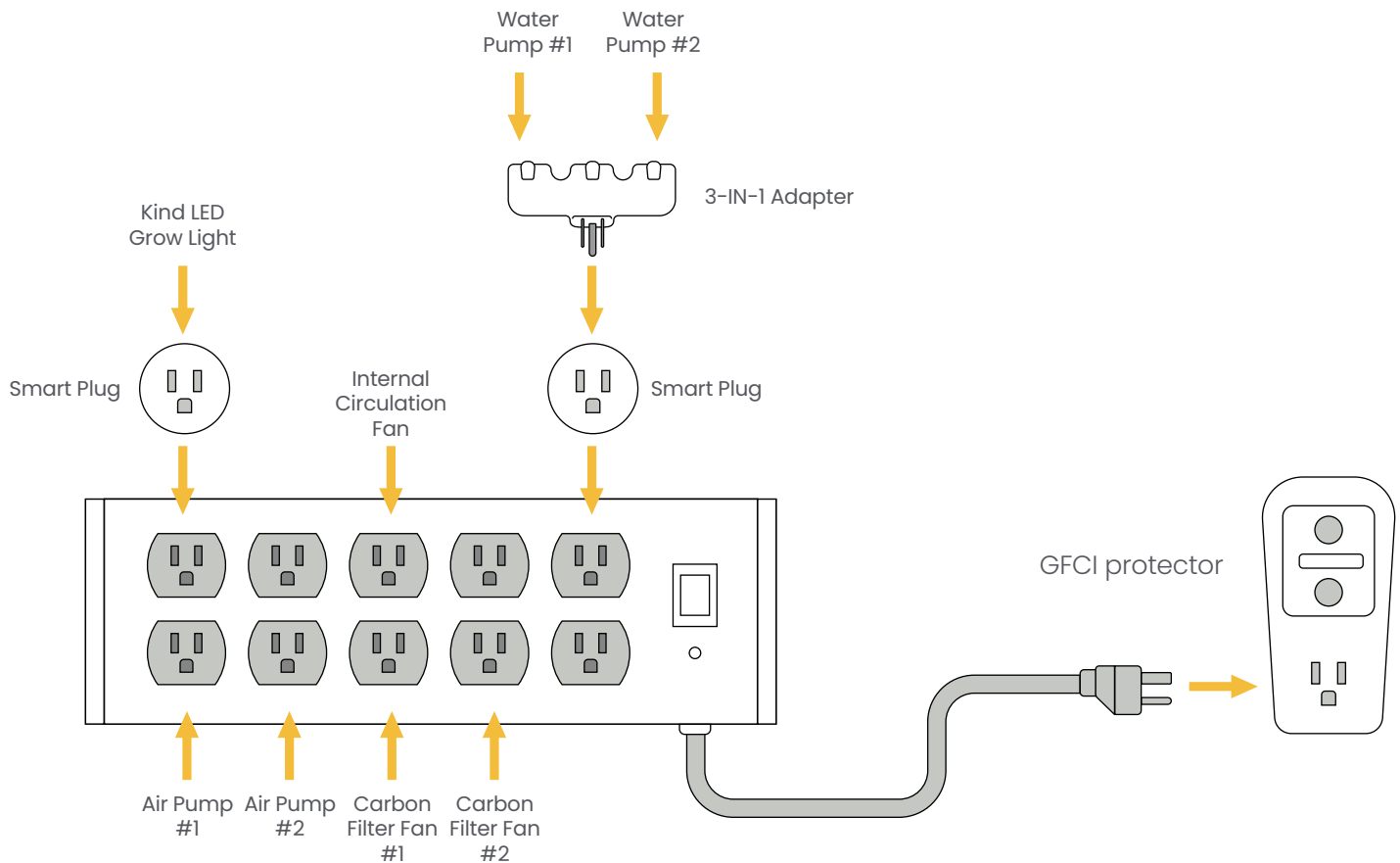

GROW STRONG.®



**NEED ASSISTANCE?
CHECK OUT OUR SUPPORT PORTAL**

WEB: gorillagrowtent.com
SUPPORT: support.growstrongindustries.com
PHONE: 1-855-448-4769