



**GORILLA GORW TENT KIT**  
**2X4 SOIL**

# **LET'S GET GROWING!**

Thank you for choosing the Gorilla Grow Tent Kit! We're excited to have you grow with us. Please read through each step of this user manual to get your Gorilla Grow Tent Kit setup for success! With the proper setup and care, this system will give you bountiful harvests for many years to come.

WEB: [gorillagrowtent.com](http://gorillagrowtent.com)  
EMAIL: [info@gorillagrowtent.com](mailto:info@gorillagrowtent.com)  
PHONE: 1-855-448-4769

# TABLE OF CONTENTS

---

Specifications	4
Components	5
Unpacking the System	7
Important	8
Set Up	9
Fill & Drain Line Installation	11
Connecting the Reservoir	12
Connecting the Reservoir Cont.	13
Air Pump Installation	16
Filling Buckets & Reservoir	19
Get the Most from Your System	20

# SPECIFICATIONS

---

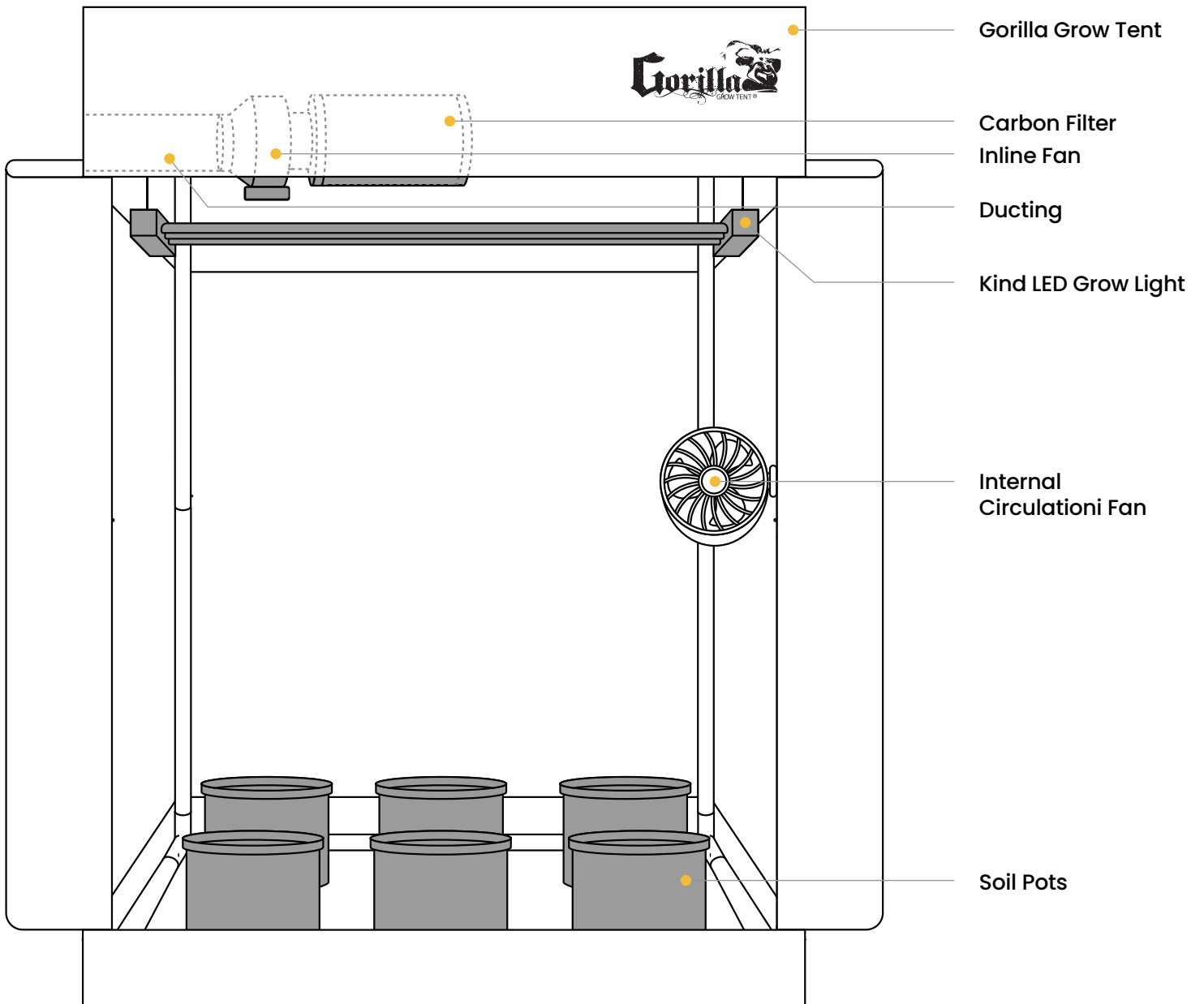

# COMPONENTS

---

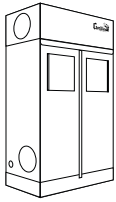

**Gorilla Grow Tent** 1



**Kind LED Grow Light** 1

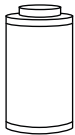

**Gorilla Carbon Filter** 1

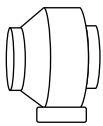

**Inline Fan** 1

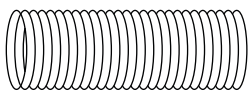

**Ducting** 1

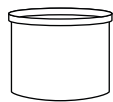

**Soil Pots** 6

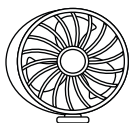

**Internal Circulation Fan** 1

# COMPONENTS

---

NAME

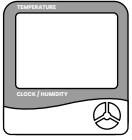

**Thermometer /  
Hygrometer** 1

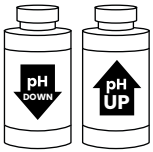

**pH Control  
Kit** 1

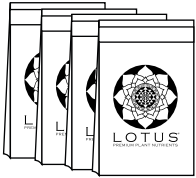

**Lotus Nutrients  
Intro Pack** 1

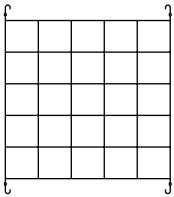

**Net Trellis** 1

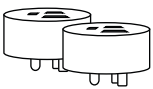

**Smart Plugs** 2

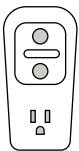

**GFCI Shock  
Buster** 6

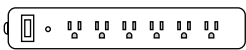

**Industrial  
Power Strip** 6

# COMPONENTS

---

NAME

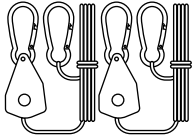

**Yo-yo Ratchet  
Hangers** 1

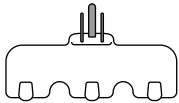

**3-in-1  
Adapter** 1

- 1

- 1

- 2

- 6

- 6

# UNPACKING THE GROW TENT KIT

---

Unpack the pallet and boxes the Grow Tent Kit came on and lay out in an organized manner.

Once all items are unpacked, reference your quality assurance checklist to verify that you have all the contents of your Grow Tent Kit.

Make sure that you have planned accordingly to ensure you have the proper amount of power and properly sized breakers going to your. Always consult a professional electrician when setting up and planning your electrical configuration.

**Quality Assurance Checklist**

- ✓ \_\_\_\_\_
- ✓ \_\_\_\_\_
- ✓ \_\_\_\_\_
- ✓ \_\_\_\_\_
- ✓ \_\_\_\_\_
- ✓ \_\_\_\_\_

*[Signature]*  
\_\_\_\_\_  
*[Signature]*  
\_\_\_\_\_

 **NOTE:** Prior to setup, make sure you have all of the necessary components by cross referencing with the QAC (Quality Assurance Checklist). Take this time to familiarize yourself with each of the components.



# SET UP GORILLA GROW TENT

Make sure you assemble the tent in its final location since it may be challenging to relocate once fully assembled. Don not plug in any of the components

yet, this will be done once the system is completely assembled.



**GROW STRONG TIP:** Use masking tape and a marker to label the power cords of the components at the plug to help identify the components later in the assembly.

1

No Extension Kit

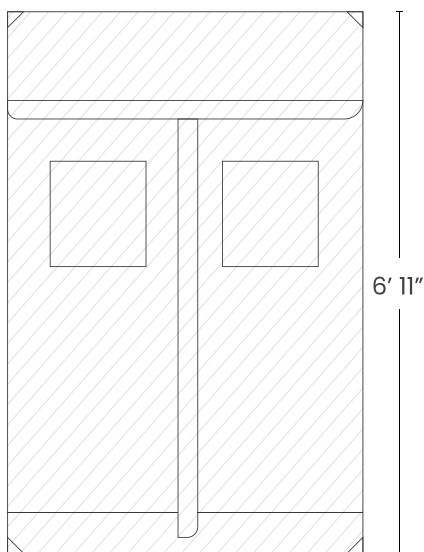

1' Extension Kit

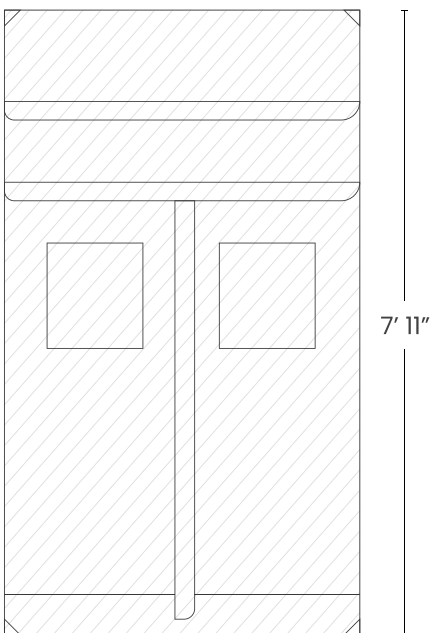

Assemble the Gorilla Grow Tent according to the manufactures included setup instructions. Determine ahead of time if you are able to assemble as a standard 6' 11" tall tent, or if you are able to maximize your space and go with the 7' 11" tall configuration.

Once your tent is assembled, double check to make sure that all fittings are installed properly including

## SET UP CARBON FILTER

---

1

### **ARE WE STILL HANGING THE FILTER WITH STRAPS? DO WE WANT TO TELL THEM TO HANG THE INLINE FAN IN THE TENT OR OUTSIDE?**

Locate Carbon Filter. Using the black straps included with the Gorilla Grow Tent, attach the filter to the ceiling support on the back wall of the tent.

2

Locate the ducting and hose clamps included in your system. Slide the hose clamp over the ducting prior to attaching the ducting to the filter. Attach one end of the ducting to the filter using the provided hose clamps and tighten for a snug fit.

3

Feed the other end of the ducting through the nearest port hole. Once the ducting is fed through the hole, use the double-cinching pulls to tighten the port around the ducting to prevent any light leaks.

# SET UP INLINE FAN

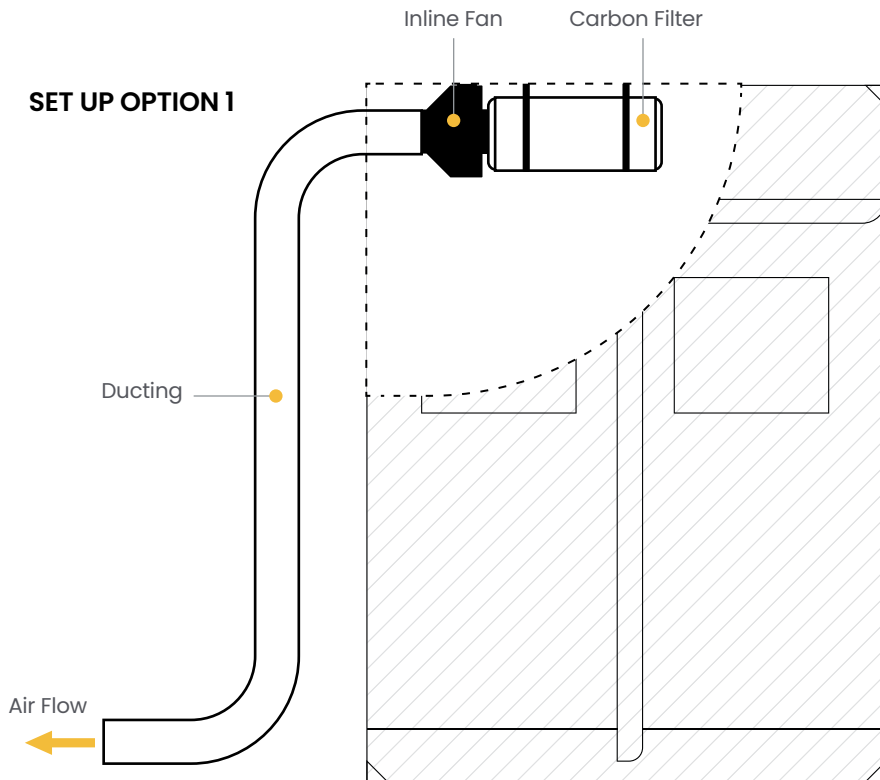

The Inline Fan will pull air from inside the tent, through the Carbon Filter, ensuring that your exhaust is free of odors and aromas.

The inline fan may be placed inside the tent, or outside the tent. Use the diagrams to the left as a reference on how each method is set up.

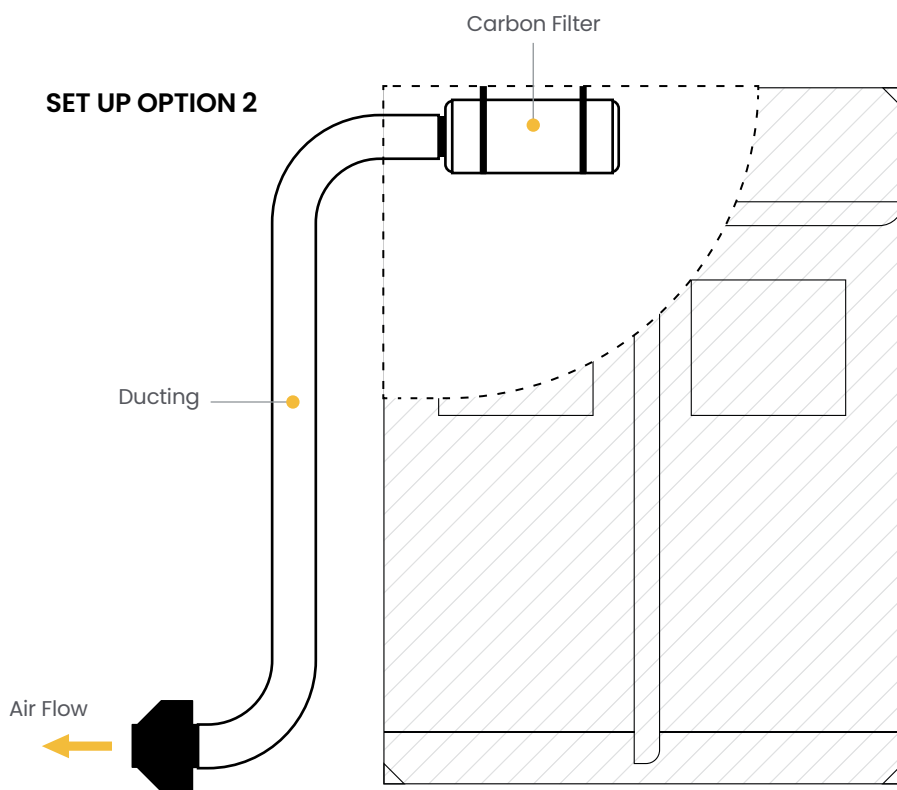

# SET UP KIND LED GROW LIGHT

1

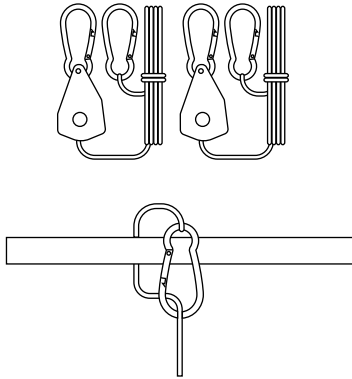

Locate the Yo-Yo light hangers. Loop the carabiner end over the top support of the tent and clip it to itself. Press the button on the side of the Yo-Yo hanger to adjust the height.

2

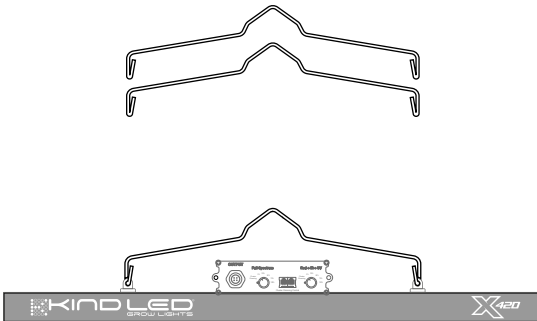

Unpack your KIND LED Grow Light and locate the wire hangers. Connect the wire hangers to each of the metal hangers on the light.

3

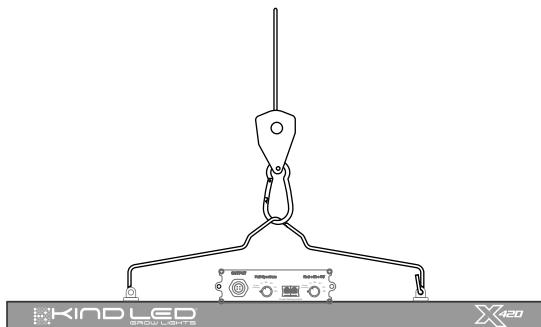

Place the Kind LED Light in the bottom of the tent. Lower the Yo-Yo system until you can connect the other ends of the cable assemblies to the Yo-Yo carabiners. Raise the light to the desired height using the loose end of the Yo-Yo hanger cord.

Run the power cord from the LED light through the nearest electrical port hole.

# SET UP THERMOMETER/HYDROMETER/ICF

---

6

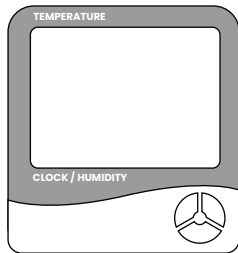

Locate the Thermometer/Hydrometer (image e). Remove the battery cover and remove the plastic safety blocker from the battery terminal. You can be creative on where you would like this placed inside the tent, but the easiest placement is inside the tool pouch on the inside of the tent.

Run the external probe to the outside of the tent, through the nearest ducting port. Make sure the probe is not touching any surface on the outside of the tent as this will provide false readings.

7

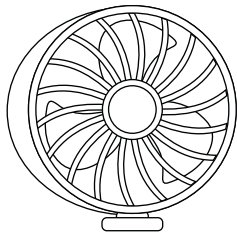

Locate the Clip-On Active Air Fan(s) (image f). Clip the fan to any one of the inside corner vertical poles. Run the cord through the nearest electrical port hole. The fan is designed to provide circulation and air movement and can be raised and lowered as needed to provide optimal air flow over the canopy.

# SET UP GROW SYSTEM



**NOTE:** Make sure you have installed the spill tray included with your Gorilla Grow Tent prior to setting up the grow system in the tent

Arrange the included pots in an orderly manner in the Gorilla Grow Tent.

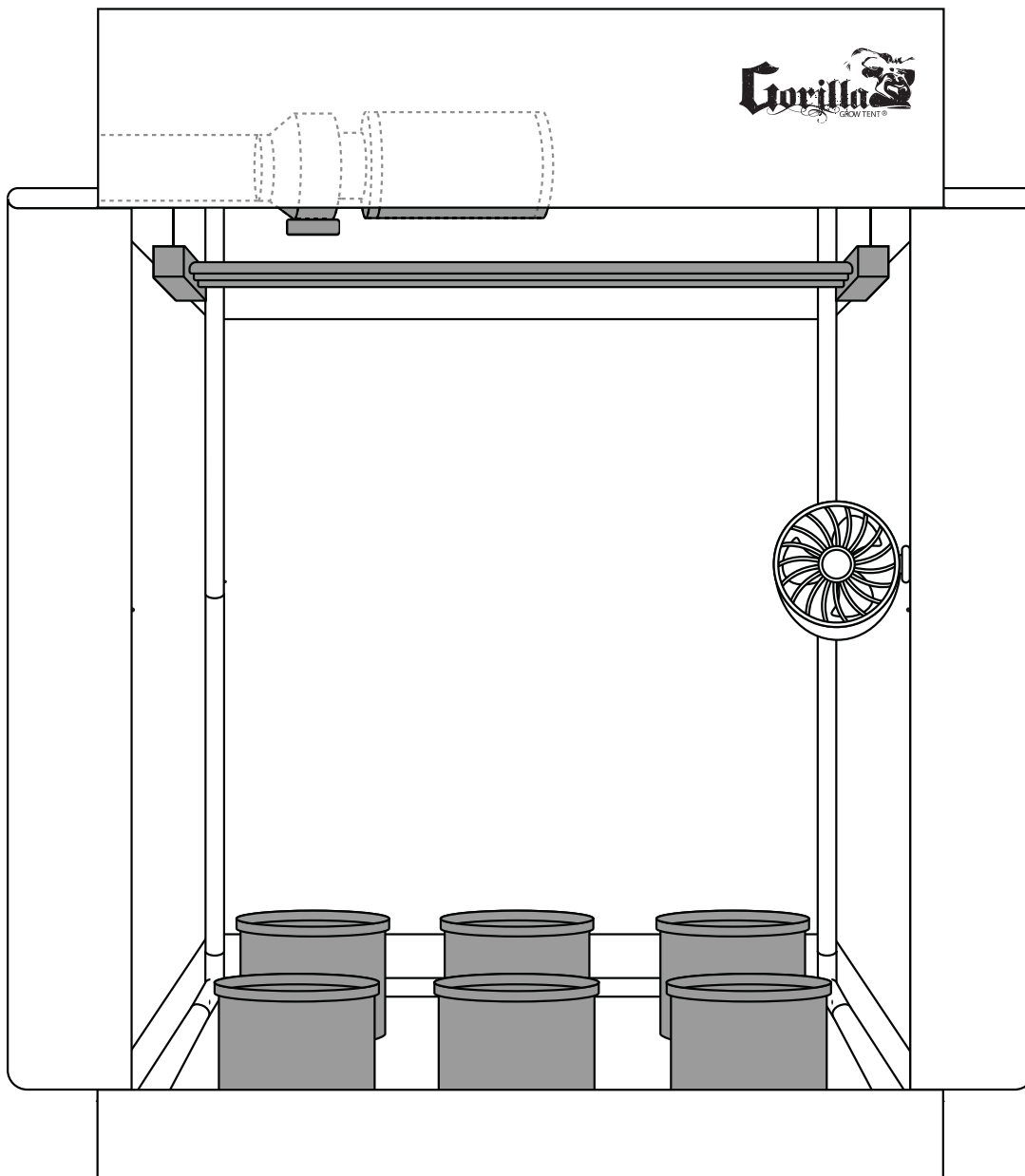

# FINAL ASSEMBLY

---

1

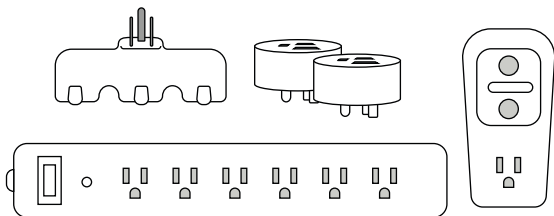

Locate the power strip, the GFCI protector, the two smart plugs, and the 3-IN-1 adapter.



**NOTE:** Do not plug in the power strip yet.

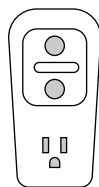

Plug the GFCI Protector into any 110v wall socket. With the power strip turned OFF, plug the power strip into the GFCI Protector.

Double check to make sure all components are set up properly. it's time to turn on the Grow Tent Kit. Turn the power strip switch to the ON position, and the system should spring to life before your very eyes!

## NEED PLUG IN DIAGRAM. PLEASE PROVIDE



## Happy with your Gorilla Grow Tent Kit?

Please consider writing a review at the place of purchase. Also, please like and share with us on Instagram @gorillagrowtent



## Not happy with your product or experience?

Please reach out to our amazing grow support staff by visiting:  
<https://support.growstrongindustries.com>